

MANEGE YOUR MOTION

DIFFERENTIAL PARTS



www.gearax.net

    /gearax

GEARAX®

Gearax olarak hafif ticari araçlar, kamyon & kamyonet, iş makinası ve off-road SUV ana gruplarında difransiyel ve yedek parçalarını üretmekteyiz. Mercedes-Benz, Volkswagen, Man, Ford, Iveco, Isuzu, Dodge, Fiat, Freightliner, Tümosan, New Holland ve Carraro marka ve modellerine uygun sürekli genişleyen ürün yelpazemiz ile sürekli büyümeye devam ediyoruz.

Gearax, günümüzün teknolojik imkanlarını takip eden ve kullanan, bünyesindeki mühendis, teknisyen ve tecrübeli çalışan kadrosu ile toplam kalite yönetim sistemini benimsemiş, otomotiv sektöründe çeşitli parçaların üretimini yapmaktadır.

Gearax, 1960'lı yıllarda OEM, OES, AFTERMARKET tedarikçisi olarak başlamış ve çelik, dövme, döküm, alüminyum gibi metallerden imal edilen aksam parçaları ve tüm diferansiyel, dişli üretim, sistem parçalarını üretmeye başlamıştır.

Firmamızda ISO 9001:2015 kalite yönetim sistemi kullanılmakta olup, kalite politikamız gereği müşterilerimize daha iyi hizmet vermek, teknolojik imkanların kullanımını üretim faaliyetlerine yansıtarak üretimimizi hızlı ve kaliteli bir seviyeye getirmek olacaktır. Tüm ürün ve hizmetlerimizin etkinliği gelişen bir kalite yönetimi, müşteri odaklı anlayış içerisinde, çalışanlarımızın ve tedarikçilerimizin ortak katılımı ile verimli ve ekonomik bir biçimde müşteri istek ve kalite standartlarını uygun olarak istenilen teslimat süresinde üretim yaparak müşterilerimizin memnuniyetini arttırmaktır.

Müşteri ihtiyaçlarını karşılamak amacıyla hammaddelerin imalattan parçaların son üretimine ve bunlarla ilişkin bilgilerin kaynaktan tüketileceği noktaya kadar etkin bir şekilde akış depolaması ve kontrol edilmesi sürecinin her düzeydeki yöneticiyi ilgilendirdiğinin bilincindeyiz.

D E Ğ E R L E R İ M İ Z

- GÜÇLÜ İŞ BİRLİKTELİKLERİNE İNANIRIZ
- ÜRETİME OLAN TUTKUMUZA İNANIRIZ
- ÇÖZÜM ODAKLI YAKLAŞIMLARA İNANIRIZ
- İLHAM OLMAYA, İLHAM VERMEYE İNANIRIZ
- SÜREKLİ PLANLI GELİŞİME İNANIRIZ

Bu beş değer bizi biz yapan en büyük değerlerimizdir...



We are manufacturing of differential spare parts in Light Commercial Vehicles, Trucks & Van , Heavy Equipments and Off-road Suv main groups.

We continue to grow with our ever-expanding product range suitable for Mercedes-Benz, Volkswagen, Man, Ford, Iveco, Isuzu, Dodge, Fiat, Freightliner, Tümosan, New Holland, and Carraro brand models.

Gearax, has adopted the total quality management system with its engineers, technicians and experienced staff, following and using today's technological opportunities, and produces various parts in the automotive sector.

Gearax started as an OEM, OES, AFTERMARKET supplier in the 1960s, and started to produce component parts and all differential, gear production and system parts made of metals such as steel, forging, casting, aluminium.

ISO 9001:2015 quality management system is used in our company, our aim, in accordance with our quality policy, will be to provide better service to our customers, to bring our production to a fast and high quality level by reflecting the use of technological opportunities to production activities. We increase the satisfaction of our customers by producing within the desired delivery time in accordance with customer requests and quality standards in an efficient and economical manner with a quality management, customer-oriented understanding, joint participation of our employees and suppliers, with the effectiveness of all our products and services.

We are aware that the process of effectively storing and controlling the flow of raw materials from the manufacturing to the final production of parts and related information from the source to the point where it is consumed in order to meet customer needs concerns managers at all levels.

OUR VALUES

- WE BELIEVE IN STRONG COOPERATION
- WE BELIEVE IN OUR PASSION FOR PRODUCTION
- WE BELIEVE IN SOLUTION-ORIENTED APPROACHES
- WE BELIEVE IN INSPIRING
- WE ALWAYS BELIEVE IN PLANNED DEVELOPMENT

These five values are our greatest values that make us who we are...



GEARAX®

MANAGE YOUR MOTION



GEARAX®

MANAGE YOUR MOTION

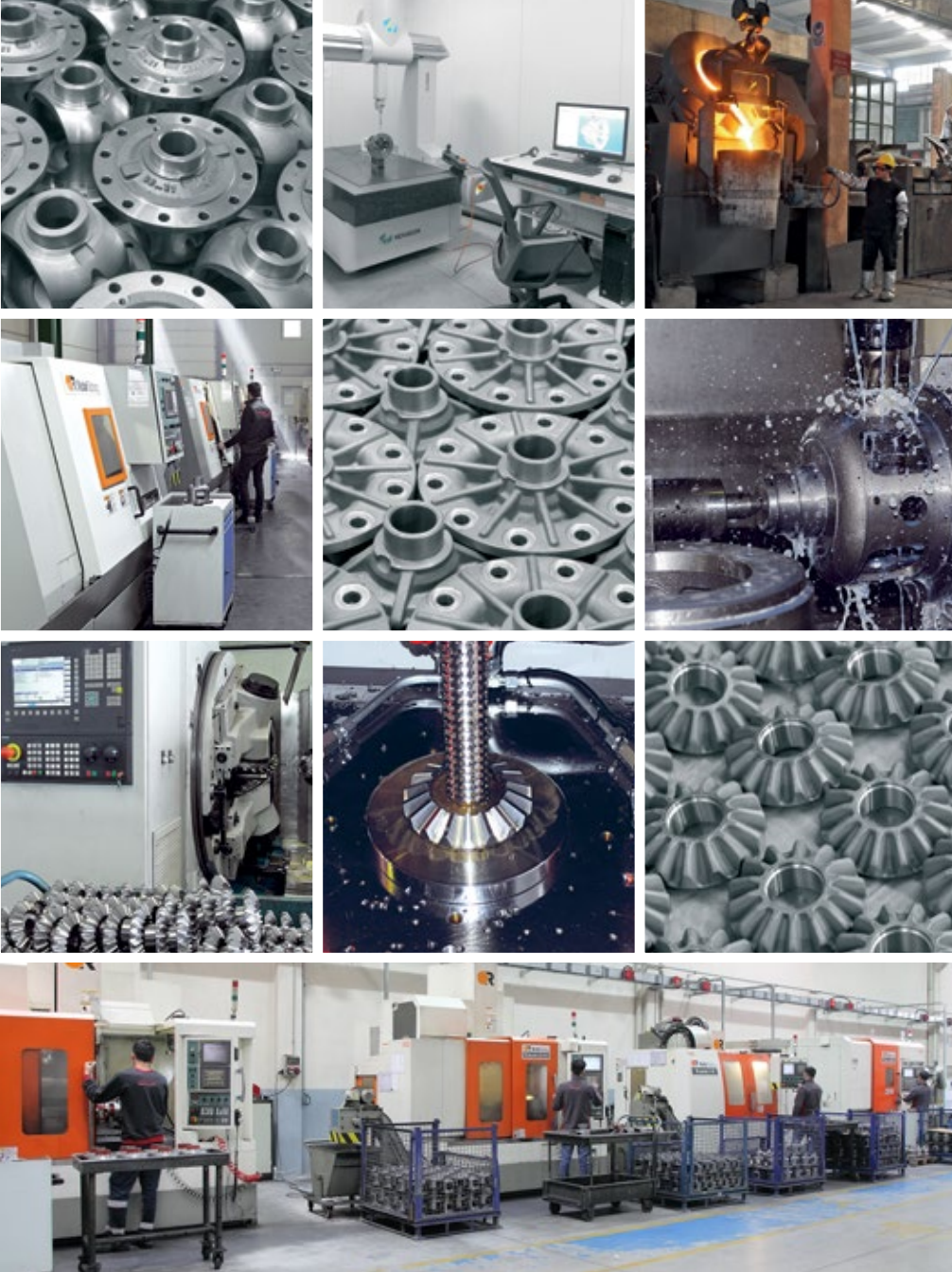

HAMMADDEDEN, ÜRETİME
HER ZAMAN EN İYİSİ...

GEARAX®

MANAGE YOUR MOTION



FROM RAW MATERIALS TO PRODUCTION
ALWAYS THE BEST...

PARÇA ADI
PART NAME

KOMPLE DİFERANSİYEL KUTUSU
COMPLETE DIFFERENTIAL BOX

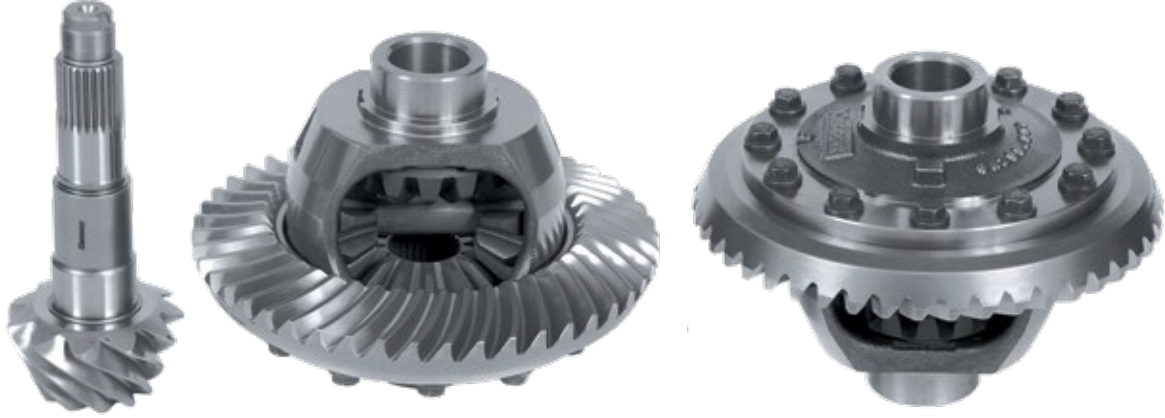

HAFİF TİCARİ / LIGHT COMMERCIAL

ARAÇLAR
VEHICLES

MERCEDES BENZ • VOLKSWAGEN • MAN • DODGE • FREIGHTLINER

ARAÇ MODELLERİ
VEHICLE MODELS

**MB • VW • SPRINTER W 906 • 2500 SERIES • 3500 SERIES • 3.0 L V6 DIESEL • DODGE SPRINTER
FREIGHTLINER • MAN TGE • TRANSPORTER • CRAFTER 30 • CRAFTER 35**

GEARAX NO	OEM NO	DİŞLİ ORANI RATİON	AYNA ÇAPI RING GEAR DIAMETER
GA200-1351	906 350 0914 906 350 2523 OBA 525 021K	13x51 1:3,923	Ø 245
GA200-1146	906 350 2423 OBA 525 021J	11x46 1:4,181	Ø 245
GA200-1148	906 350 2323 906 350 4323 OBA 525 021H	11x48 1:4,363	Ø 245
GA200-1152	906 350 0814 906 350 2223 906 350 5123 OBA 525 021G	11x52 1:4,727	Ø 245
GA200-1348	906 350 4623 OBA 525 021	13x48 1:3,692	Ø 245

PARÇA ADI
PART NAME

KOMPLE DİFERANSİYEL KUTUSU
COMPLETE DIFFERENTIAL BOX



HAFİF TİCARİ / LIGHT COMMERCIAL

ARAÇLAR
VEHICLES

MERCEDES BENZ • VOLKSWAGEN • MAN • DODGE • FREIGHTLINER

ARAÇ MODELLERİ
VEHICLE MODELS

**MB • VW • SPRINTER W 906 • 2500 SERIES • 3500 SERIES • DODGE SPRINTER
FREIGHTLINER • MAN TGE • TRANSPORTER • CRAFTER 30 • CRAFTER 35**

GEARAX NO	OEM NO	DİŞLİ ORANI RATİON	AYNA ÇAPI RING GEAR DIAMETER
GA300-1351	906 350 0514 906 350 1523 0BA 525 021M	13x51 1:3,923	Ø 215
GA300-1146	906 350 1423 0BA 525 021A 2E0 525 107	11x46 1:4,181	Ø 215
GA300-1148	906 350 0314 906 350 2023 906 350 3123 0BA 525 021E	11x48 1:4,363	Ø 215

PARÇA ADI
PART NAME**KOMPLE DİFERANSİYEL KUTUSU V184**
COMPLETE DIFFERENTIAL BOX V184

HAFİF TİCARİ / LIGHT COMMERCIAL

ARAÇLAR
VEHICLES

FORD

ARAÇ MODELLERİ
VEHICLE MODELS

V184 • TRANSIT

GEARAX NO	OEM NO
GA500	YC1W 4205AA-4041470 YC1W 4027 CA

PARÇA ADI
PART NAME**AYNA MAHRUTİ DİŞLİ SETİ 8X35**
CROWN WHEEL & PINION SET 8X35

HAFİF TİCARİ / LIGHT COMMERCIAL

ARAÇLAR
VEHICLES**MERCEDES BENZ • VOLKSWAGEN • MAN • DODGE • FREIGHTLINER****ARAÇ MODELLERİ**
VEHICLE MODELSMB • VW • VOLT LT30 • LT35 • LT46 • FREIGHTLINER SPRINTER • DODGE SPRINTER • SPRINTER
W901 • W902 • W903 • W904 • DB 507 • DB 508 • VARIO 512

GEARAX NO	OEM NO	DİŞLİ ORANI RATİON	AYNA ÇAPI RING GEAR DIAMETER
GA603-01-8X35	6013502639 9043500039 6023501539 2D0525143N	8x35 1:4,375	Ø 215

PARÇA ADI
PART NAME**AYNA MAHRUTİ DİŞLİ SETİ 11X46**
CROWN WHEEL & PINION SET 11X46

HAFİF TİCARİ / LIGHT COMMERCIAL

ARAÇLAR
VEHICLES

IVECO

ARAÇ MODELLERİ
VEHICLE MODELS

IVECO DAILY • 49.10 • 49.12

GEARAX NO	OEM NO	DİŞLİ ORANI RATİON	AYNA ÇAPI RING GEAR DIAMETER
GA600-01-11X46	7175158	11X46 1:5,909	Ø 240

PARÇA ADI
PART NAME**AYNA MAHRUTİ DİŞLİ SETİ 13X47**
CROWN WHEEL & PINION SET 13X47

HAFİF TİCARİ / LIGHT COMMERCIAL

ARAÇLAR
VEHICLES

IVECO

ARAÇ MODELLERİ
VEHICLE MODELS

IVECO DAILY

GEARAX NO	OEM NO	DİŞLİ ORANI RATİON	AYNA ÇAPI RING GEAR DIAMETER
GA600-02-13X47	7174007	13X47 1:3,615	Ø 240

PARÇA ADI
PART NAME

KOMPLE DİFERANSİYEL KUTUSU AYARLI 12MM ÇİFT TEKER
COMPLETE DIFFERENTIAL BOX ADJUSTABLE 12MM DOUBLE WHEEL



HAFİF TİCARİ / LIGHT COMMERCIAL

ARAÇLAR
VEHICLES

KIA

ARAÇ MODELLERİ
VEHICLE MODELS

BONGO

GEARAX NO

OEM NO

GA400

OK60A-27200A

PARÇA ADI
PART NAME

BÜYÜK İSTAVROZ AKS TAMİR TAKIM KİTİ
LARGE DIVERSE AXLE REPAIR KIT



HAFİF TİCARİ / LIGHT COMMERCIAL

ARAÇLAR
VEHICLES

MERCEDES BENZ • VOLKSWAGEN • MAN • DODGE • FREIGHTLINER

ARAÇ MODELLERİ
VEHICLE MODELS

**MB • VW • SPRINTER W 906 • 2500 SERIES • 3500 SERIES • 3.0 L V6 DIESEL • DODGE SPRINTER
FREIGHTLINER • MAN TGE • TRANSPORTER • CRAFTER 30 • CRAFTER 35**

GEARAX NO	OEM NO
GA200-018	906 350 0914
	906 350 2523
	0BA 525 021K
	906 350 2423
	0BA 525 021J
	906 350 2323
	906 350 4323
	0BA 525 021H
	906 350 0814
	906 350 2223
	906 350 5123
	0BA 525 021G
	906 350 4623
	0BA 525 021

PARÇA ADI
PART NAME**KÜÇÜK İSTAVROZ AKS TAMİR TAKIM KİTİ**
SMALL DIVERSE AXLE REPAIR KIT

HAFİF TİCARİ / LIGHT COMMERCIAL

ARAÇLAR
VEHICLES**MERCEDES BENZ • VOLKSWAGEN • MAN • DODGE • FREIGHTLINER****ARAÇ MODELLERİ**
VEHICLE MODELSMB • VW • SPRINTER W 906 • 2500 SERIES • 3500 SERIES • DODGE SPRINTER
FREIGHTLINER • MAN TGE • TRANSPORTER • CRAFTER 30 • CRAFTER 35

GEARAX NO	OEM NO
GA300-016	906 350 0514 906 350 1523 OBA 525 021M 906 350 1423 OBA 525 021A 2E0 525 107 906 350 0314 906 350 2023 906 350 3123 OBA 525 021E

PARÇA ADI
PART NAME**KOMPLE DİFERANSİYEL KUTUSU YENİ**
COMPLETE DIFFERENTIAL BOX NEW

İŞ MAKİNASI / EARTH MOVER

ARAÇLAR
VEHICLES**TÜMOSAN • NEW HOLLAND • CASE • FIAT****ARAÇ MODELLERİ**
VEHICLE MODELS**TÜM MODELLER / ALL MODELS**

GEARAX NO	OEM NO
GA100	7261436 84345898 87523515

PARÇA ADI
PART NAME

KOMPLE DİFERANSİYEL KUTUSU EX
COMPLETE DIFFERENTIAL BOX EX



İŞ MAKİNASI / EARTH MOVER

ARAÇLAR
VEHICLES

TÜMOSAN • NEW HOLLAND • CASE • FIAT

ARAÇ MODELLERİ
VEHICLE MODELS

TÜM MODELLER / ALL MODELS

GEARAX NO	OEM NO
GA101	7258856 7253229 84345898 87523515

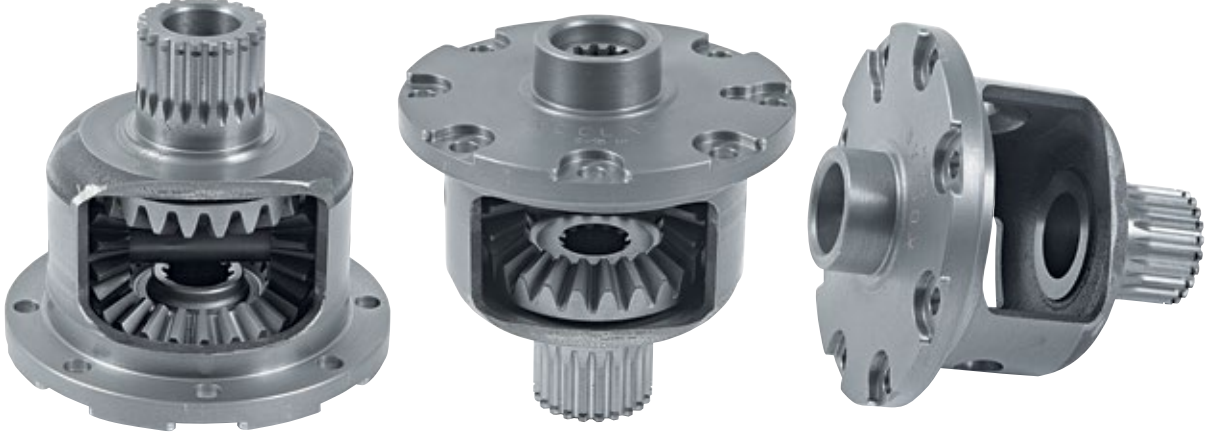
PARÇA ADI
PART NAME**KOMPLE DİFERANSİYEL KUTUSU DT**
COMPLETE DIFFERENTIAL BOX DT

İŞ MAKİNASI / EARTH MOVER

ARAÇLAR
VEHICLES**TÜMOSAN • CARRARO****ARAÇ MODELLERİ**
VEHICLE MODELS**TÜM MODELLER / ALL MODELS**

GEARAX NO	OEM NO
GA102	7254626

PARÇA ADI
PART NAME

KOMPLE AYNA MAHRUTİ DİFERANSİYEL KUTUSU YENİ
COMPLETE DIFFERENTIAL BOX/CROWN WHEEL&PINION SET NEW



ARAÇLAR
VEHICLES

NEW HOLLAND • CASE • TÜMOSAN • FIAT

ARAÇ MODELLERİ
VEHICLE MODELS

TÜM MODELLER / ALL MODELS

GEARAX NO	OEM NO	DİŞLİ ORANI RATİON	AYNA ÇAPI RING GEAR DIAMETER
GA103	7261436 84345898 87523515	9X41 1:4,55	Ø 307

PARÇA ADI
PART NAME**KOMPLE AYNA MAHRUTİ DİFERANSİYEL KUTUSU EX**
COMPLETE DIFFERENTIAL BOX/CROWN WHEEL&PINION SET EX**ARAÇLAR**
VEHICLES**NEW HOLLAND • CASE • TÜMOSAN • FIAT****ARAÇ MODELLERİ**
VEHICLE MODELS**TÜM MODELLER / ALL MODELS**

GEARAX NO	OEM NO	DİŞLİ ORANI RATİON	AYNA ÇAPI RING GEAR DIAMETER
GA104	7258856 7253229 84345898 87523515	9X41 1:4,55	Ø 307

PARÇA ADI
PART NAME

DİFERANSİYEL KUTUSU T580
DIFFERENTIAL BOX T580



İŞ MAKİNASI / EARTH MOVER

ARAÇLAR
VEHICLES

TÜMOSAN • CARRARO • ZF

ARAÇ MODELLERİ
VEHICLE MODELS

TÜM MODELLER / ALL MODELS

GEARAX NO	OEM NO
GA105	7259717

PARÇA ADI
PART NAME**AYNA MAHRUTİ DİŞLİ SETİ 9X41**
CROWN WHEEL & PINION SET 9X41

İŞ MAKİNASI / EARTH MOVER

ARAÇLAR
VEHICLES**TÜMOSAN****ARAÇ MODELLERİ**
VEHICLE MODELS**TÜM MODELLER / ALL MODELS**

GEARAX NO	OEM NO	DİŞLİ ORANI RATION	AYNA ÇAPI RING GEAR DIAMETER
GA604-01-9X41	5117043 7255738	9X41 1:4,55	Ø 307

PARÇA ADI
PART NAME**AKS TAMİR TAKIM SETİ 4X4**
AXLE GEAR REPAIR KIT 4X4**ARAÇLAR**
VEHICLES**FORD****ARAÇ MODELLERİ**
VEHICLE MODELS**FORD RANGER**

GEARAX NO	OEM NO
GA501	XM344236AB XM343A394AA

PARÇA ADI
PART NAME**AYNA MAHRUTİ DİŞLİ SETİ 14X43**
CROWN WHEEL & PINION SET 14X43

ARAZİ, SUV & PICKUP / SUV OFF ROAD

ARAÇLAR
VEHICLES**ISUZU****ARAÇ MODELLERİ**
VEHICLE MODELS

ISUZU D-MAX • EURO5

GEARAX NO	OEM NO	DİŞLİ ORANI RATİON	AYNA ÇAPI RING GEAR DIAMETER
GA602-02-14X43	8981571751	14X43 1:3,071	Ø 190

PARÇA ADI
PART NAME**AYNA MAHRUTİ DİŞLİ SETİ 6X37**
CROWN WHEEL & PINION SET 6X37

KAMYON&KAMYONET / TRUCK

ARAÇLAR
VEHICLES**mitsubishi temsa****ARAÇ MODELLERİ**
VEHICLE MODELS

mitsubishi canter • bus • prestij • m14

GEARAX NO	OEM NO	DİŞLİ ORANI RATION	AYNA ÇAPI RING GEAR DIAMETER
GA601-01-6X37	MC-863589N	6X37 1:6,16	Ø 305

PARÇA ADI
PART NAME**AYNA MAHRUTİ DİŞLİ SETİ 6X40**
CROWN WHEEL & PINION SET 6X40

KAMYON&KAMYONET / TRUCK

ARAÇLAR
VEHICLES**MITSUBISHI****ARAÇ MODELLERİ**
VEHICLE MODELS

MITSUBISHI CANTER • 449 • BUS PRESTIJ • M14

GEARAX NO	OEM NO	DİŞLİ ORANI RATION	AYNA ÇAPI RING GEAR DIAMETER
GA601-02-6X40	MC-863589	6X40 1:6,66	Ø 305

PARÇA ADI
PART NAME**AYNA MAHRUTİ DİŞLİ SETİ 7X40**
CROWN WHEEL & PINION SET 7X40

KAMYON&KAMYONET / TRUCK

ARAÇLAR
VEHICLES**mitsubishi****ARAÇ MODELLERİ**
VEHICLE MODELS

mitsubishi canter • FE 659 T • BUS PRESTIJ

GEARAX NO	OEM NO	DİŞLİ ORANI RATION	AYNA ÇAPI RING GEAR DIAMETER
GA601-03-7X40	MC-892178	7X40 1:5,71	Ø 305

PARÇA ADI
PART NAME**AYNA MAHRUTİ DİŞLİ SETİ 7X41**
CROWN WHEEL & PINION SET 7X41

KAMYON&KAMYONET / TRUCK

ARAÇLAR
VEHICLES

ISUZU

ARAÇ MODELLERİ
VEHICLE MODELS

ISUZU NPR 59 M12

GEARAX NO	OEM NO	DİŞLİ ORANI RATİON	AYNA ÇAPI RING GEAR DIAMETER
GA602-01-7X41	8-97035-454-0	7X41 1:5,85	Ø 292

PARÇA ADI
PART NAME**AYNA MAHRUTİ DİŞLİ SETİ 7X43**
CROWN WHEEL & PINION SET 7X43

KAMYON&KAMYONET / TRUCK

ARAÇLAR
VEHICLES**ISUZU****ARAÇ MODELLERİ**
VEHICLE MODELS

ISUZU NPR 66 M14

GEARAX NO	OEM NO	DİŞLİ ORANI RATİON	AYNA ÇAPI RING GEAR DIAMETER
GA602-03-7X43	8-97320-103-0	7X43 1:6,14	Ø 292

PARÇA ADI
PART NAME**AYNA MAHRUTİ DİŞLİ SETİ 7X41**
CROWN WHEEL & PINION SET 7X41

KAMYON&KAMYONET / TRUCK

ARAÇLAR
VEHICLES**ISUZU****ARAÇ MODELLERİ**
VEHICLE MODELS

ISUZU NPR 59 M14 • ISUZU NPR 71 M14

GEARAX NO	OEM NO	DİŞLİ ORANI RATION	AYNA ÇAPI RING GEAR DIAMETER
GA602-04-7X41	8-98092-031-0 8-97319-161-0	7X41 1:5,85	Ø 292

PARÇA ADI
PART NAME**AYNA MAHRUTİ DİŞLİ SETİ 7X43**
CROWN WHEEL & PINION SET 7X43

KAMYON&KAMYONET / TRUCK

ARAÇLAR
VEHICLES

ISUZU

ARAÇ MODELLERİ
VEHICLE MODELS

ISUZU NPR 66 M12

GEARAX NO	OEM NO	DİŞLİ ORANI RATİON	AYNA ÇAPI RING GEAR DIAMETER
GA602-05-7X43	8-97035-455-0	7X43 1:6,14	Ø 292

PARÇA ADI
PART NAME**AYNA MAHRUTİ DİŞLİ SETİ 13X40**
CROWN WHEEL & PINION SET 13X40

KAMYON&KAMYONET / TRUCK

ARAÇLAR
VEHICLES**MERCEDES****ARAÇ MODELLERİ**
VEHICLE MODELS

AXOR • ACTROS 1842 • AROCS • EURO6

GEARAX NO	OEM NO	DİŞLİ ORANI RATİON	AYNA ÇAPI RING GEAR DIAMETER
GA605-01-13X40	960 353 0210 960 353 0212	13X40 1:3,076	Ø 440

PARÇA ADI
PART NAME**AKS TAMİR TAKİM SETİ**
AXLE REPAIR KIT

KAMYON&KAMYONET / TRUCK

ARAÇLAR
VEHICLES**MERCEDES****ARAÇ MODELLERİ**
VEHICLE MODELS

AXOR • ACTROS 1842 • EURO6

GEARAX NO**OEM NO****GA605-02****948 350 0123**

PARÇA ADI
PART NAME**PLANET DİŞLİ GÖVDESİ**
PLANETARY CARRIER

İŞ MAKİNASI / EARTH MOVER

ARAÇLAR
VEHICLES**MASSEY FERGUSON • MF****ARAÇ MODELLERİ**
VEHICLE MODELS**TÜM MODELLER / ALL MODELS**

GEARAX NO	OEM NO
GA606	6005019450 0011330760 4301238H2

PARÇA ADI
PART NAME

KOVAN AYAR SHIM
ADJUSTMENT SHIM



HAFİF TİCARİ / LIGHT COMMERCIAL

ARAÇLAR
VEHICLES

MERCEDES BENZ • VOLKSWAGEN • MAN • DODGE • FREIGHTLINER

ARAÇ MODELLERİ
VEHICLE MODELS

**MB • VW • SPRINTER W 906 • 2500 SERIES • 3500 SERIES • DODGE SPRINTER
FREIGHTLINER • MAN TGE • TRANSPORTER • CRAFTER 30 • CRAFTER 35**

GEARAX NO	OEM NO			SHIM KALINLIĞI SHIM THICKNESS			
GA300-017	A 906 990 09 82	A 906 990 31 82	A 906 990 53 82	4,90	5,35	5,66	6,02
	A 906 990 11 82	A 906 990 33 82	A 906 990 55 82	5,02	5,38	5,70	6,06
	A 906 990 13 82	A 906 990 35 82	A 906 990 57 82	5,06	5,40	5,74	6,10
	A 906 990 15 82	A 906 990 37 82	A 906 990 59 82	5,10	5,42	5,78	6,14
	A 906 990 17 82	A 906 990 39 82	A 906 990 61 82	5,14	5,45	5,80	6,20
	A 906 990 19 82	A 906 990 41 82	A 906 990 63 82	5,18	5,46	5,82	6,22
GA200-023	A 906 990 21 82	A 906 990 43 82	A 906 990 65 82	5,22	5,50	5,85	6,30
	A 906 990 23 82	A 906 990 45 82	A 906 990 68 82	5,25	5,55	5,86	6,38
	A 906 990 25 82	A 906 990 47 82	A 906 990 69 82	5,26	5,54	5,90	
	A 906 990 27 82	A 906 990 49 82	A 906 990 73 82	5,30	5,58	5,94	
	A 906 990 29 82	A 906 990 51 82	A 906 990 77 82	5,34	5,62	5,98	

PARÇA ADI
PART NAME**MAHRUTİ BORUSU**
CRUSH SLEEVE

HAFİF TİCARİ / LIGHT COMMERCIAL

ARAÇLAR
VEHICLES**MERCEDES BENZ • VOLKSWAGEN • MAN • DODGE • FREIGHTLINER****ARAÇ MODELLERİ**
VEHICLE MODELS**MB • VW • SPRINTER W 906 • 2500 SERIES • 3500 SERIES • DODGE SPRINTER
FREIGHTLINER • MAN TGE • TRANSPORTER • CRAFTER 30 • CRAFTER 35**

GEARAX NO	OEM NO
GA300-018	906 353 00 53
GA200-023	A 906 353 00 53

UNLEASH YOUR VEHICLE'S POTENTIAL

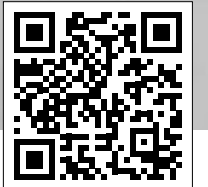
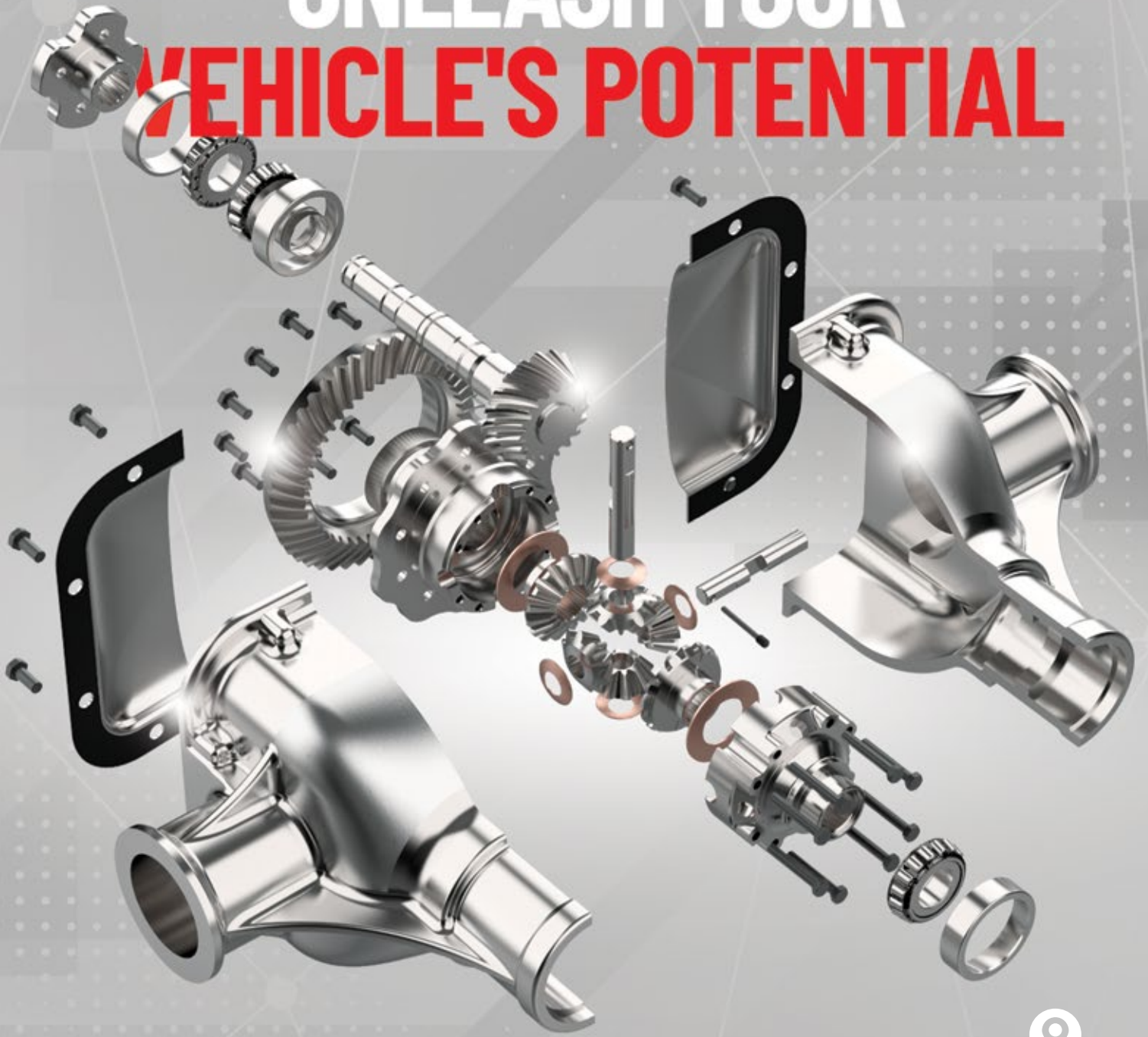

GEARAX®

MANAGE **YOUR** MOTION



 Fevzi Çakmak Mah. Ayyıldız Cad. No:103J PK.42050 Karatay/KONYA/TÜRKİYE

 info@gearax.net

 +90 332 248 85 64

 www.gearax.net

